

LHC実験 Higgs粒子を探して

12/14/2007

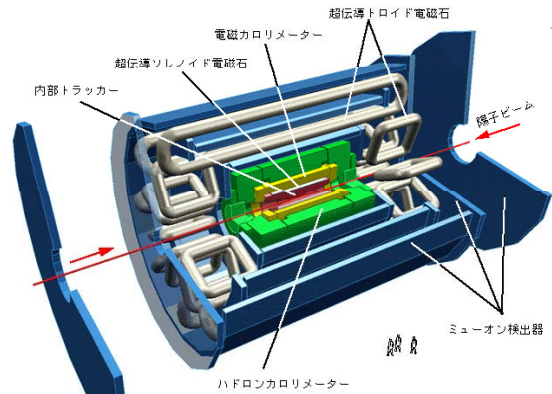

The Large Hadron Collider (LHC)

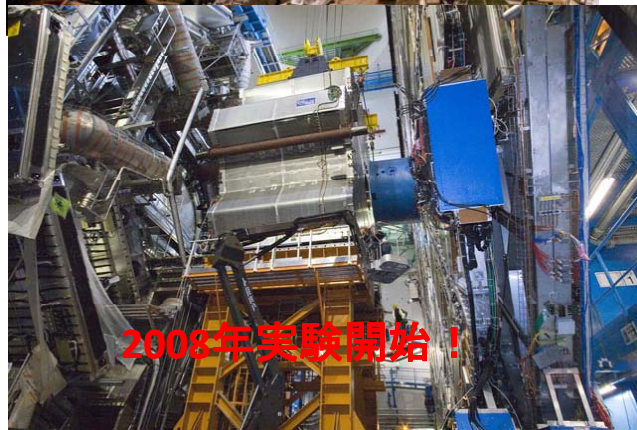
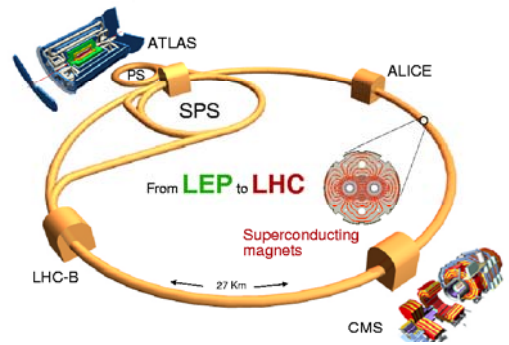

アトラス実験装置

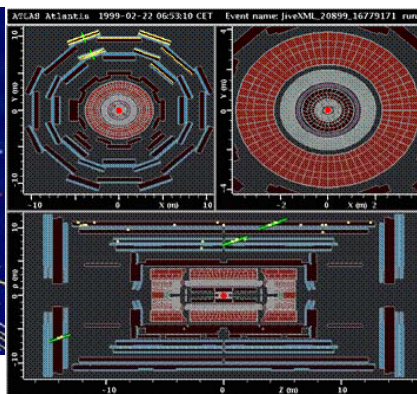
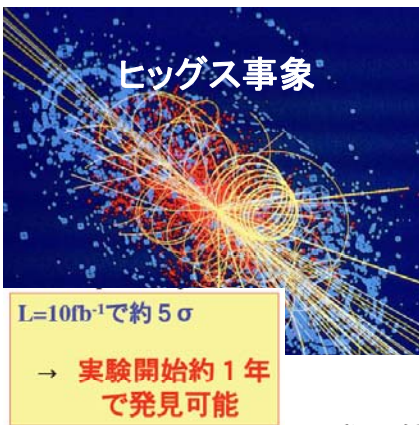

(2) $H \rightarrow ZZ^* \rightarrow 4\text{leptons}$

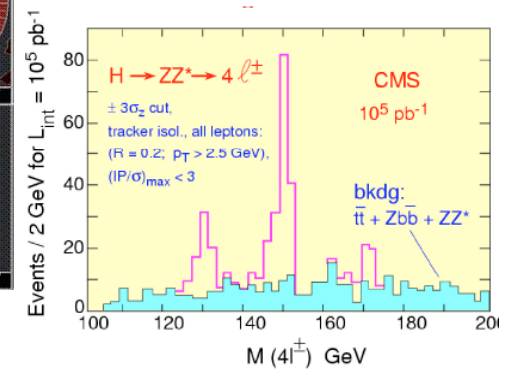

1-4 SM Higgsの発見能力

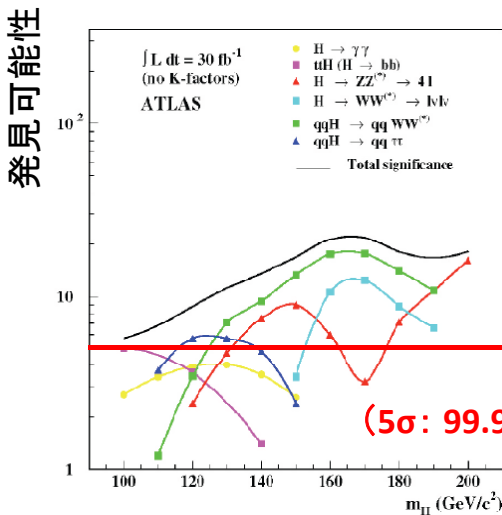

ヒッグス粒子の性質: クォークレプトンとの結合定数が各粒子の質量に比例する。

$$t > b > \tau$$

結合定数 (相対比) の測定精度

