

A test experiment to develop a 3D grid-like neutrino detector with a water target for measurement of neutrino cross sections at the near detector hall of J-PARC neutrino beam-line

A. Bonnemaïson, O. Drapier, O. Ferreira, M. Gonin, Th.A. Mueller, and B. Quilain
Ecole Polytechnique, IN2P3-CNRS, Laboratoire Leprince-Ringuet, Palaiseau, France

I. Ayzenberg, A. Izmaylov, I. Karpikov, M. Khabibullin, A. Khotjantsev, Y. Kudenko, S. Martynenko, A. Mefodiev, O. Mineev, T. Ovsjannikova, S. Suvorov, and N. Yershov
Institute for Nuclear Research of the Russian Academy of Sciences, Moscow, Russia

T. Hayashino, A.K. Ichikawa, A. Minamino, K. Nakamura, T. Nakaya, and K. Yoshida
Kyoto University, Department of Physics, Kyoto, Japan

Y. Seiya, K. Wakamatsu, and K. Yamamoto
Osaka City University, Department of Physics, Osaka, Japan

N. Chikuma, T. Koga, and M. Yokoyama
University of Tokyo, Department of Physics, Tokyo, Japan

Y. Hayato
University of Tokyo, Institute for Cosmic Ray Research, Kamioka Observatory, Kamioka, Japan

April 22, 2014

Abstract

We propose a test experiment to develop a new neutrino detector with a water target at the near detector hall of J-PARC neutrino beamline.

In this experiment, we will develop a 3D grid-like neutrino detector and test its basic performance to measure neutrino cross sections on water with high precision using a neutrino beam. Once the performance is proved to be as expected, we will be able to measure the water to hydrocarbon charged current cross section ratio with 3% precision using the detector, which may be used to reduce the uncertainty on neutrino cross sections for T2K oscillation analyses.

1 Motivation

The T2K (Tokai-to-Kamioka) experiment is a long baseline neutrino oscillation experiment. In 2013, T2K made the first observation of electron neutrino appearance in a muon neutrino beam with a 7.3σ significance and constrained the CP violating phase δ_{CP} based on a data set corresponding to 8.4% of the approved delivered Protons On Target (POT) [1]. T2K will aim to measure CP violation ($\sin \delta_{CP} \neq 0$) with increasing POT.

T2K uses Super-Kamiokande (SK) as the far detector to measure neutrino interactions at a distance of 295 km from the accelerator, and near detectors at J-PARC to sample the neutrino flux just after production. The near detectors consist of an on-axis Interactive Neutrino Grid detector (INGRID) and an off-axis detector, ND280. Uncertainties on neutrino flux and cross sections for T2K oscillation analyses are largely constrained by the ND280 measurement. However, systematic parameters for neutrino cross sections, which are target nuclei dependent, cannot be constrained by the ND280 measurement because the target nuclei in SK, water, are different from the primary target nuclei of ND280, hydrocarbon. The uncertainty (rms/mean in %) on the predicted number of signal ν_e events for each group of systematic uncertainties in the ν_e appearance analysis [1] is shown in Table 1. In order to fully exploit the statistical power, there is an urgent need to reduce target-nuclei-dependent neutrino cross section errors. Neutrino interaction models predict that the target nuclei dependence is small, but there is no measurement to confirm the predictions so far. Therefore, if a water to hydrocarbon cross section ratio is measured with high precision, the target-nuclei-dependent errors can be constrained by the ND280 measurement. The ND280 has water target regions, and there are ongoing efforts in the ND280 to measure neutrino cross sections on water in order to reduce target-nuclei-dependent neutrino cross section errors.

Table 1: Uncertainty (rms/mean in %) on the predicted number of signal ν_e events for each group of systematic uncertainties for $\sin^2 2\theta_{13} = 0.1$ and $\sin^2 2\theta_{13} = 0$ in the ν_e appearance analysis [1].

Error source [%]	$\sin^2 2\theta_{13} = 0.1$	$\sin^2 2\theta_{13} = 0$
Beam flux and ν interaction	2.9	4.8
Target-nuclei-dependent ν interaction	7.5	6.8
Far detector performance	3.5	7.3
+ π interactions		
Total	8.8	11.1

We measured the ν_μ inclusive charged current cross section at neutrino energies around 1 GeV on iron and hydrocarbon using the on-axis near detector, INGRID. INGRID consists

of 16 identical standard modules and a variant module called Proton Module. Each standard module has a sandwich structure of iron target plates and scintillator trackers. On the other hand, the Proton Module is a fully-active tracking detector which consists of only scintillator trackers. The Proton Module is located at the beam center between the horizontal and vertical standard modules (Fig. 1). The measured inclusive charged current cross section on iron is $(1.4444 \pm 0.023(stat.)^{+0.1901}_{-0.1571}(syst.)) \times 10^{-38} \text{cm}^2/\text{nucleon}$, that on hydrocarbon is $(1.3790 \pm 0.085(stat.)^{+0.1808}_{-0.1503}(syst.)) \times 10^{-38} \text{cm}^2/\text{nucleon}$, and their ratio is $1.0474 \pm 0.0067(stat.)^{+0.0265}_{-0.0256}(syst.)$ for a mean neutrino energy of 1.51 GeV[2]. In the cross section ratio measurement, we have canceled the dominant systematic error, the neutrino flux error, by comparing the cross-section results from two modules, the horizontal center standard module and the Proton Module, which have different target nuclei but almost identical neutrino fluxes, and 3% precision is achieved. The result of the cross section ratio measurement agrees well with the predicted values from neutrino interaction models, NEUT[3] and GENIE[4] as shown in Fig. 2.

In the test experiment, we will develop a new neutrino detector to measure neutrino cross sections on water and hydrocarbon with high precision and large angular acceptance. A new idea, a 3D grid-like structure of scintillator bars, is adopted to detect tracks of charged particles with 4π angular acceptance and high efficiency. Advantages of this detector over the ND280 are larger angular acceptance and larger mass ratio of water to scintillator bars. We have two goals in this test experiment. The first goal is to test the basic performance of the detector, such as track reconstruction efficiency and particle identification capability using neutrino beam data, and confirm the capability of measuring the cross section. Once the performance is proved to be as expected, the second goal is to measure the water to hydrocarbon charged current cross section ratio with 3% precision, using the analysis technique established in the INGRID measurement. The purpose of the cross section measurement is to reduce the uncertainty on neutrino cross sections for T2K oscillation analyses. In order to achieve the above goals of the experiment, we would like to use the B2 floor of the near detector hall of J-PARC neutrino beam-line as a test facility of the neutrino beam. We request 1×10^{21} POT of ν (not anti- ν) beam for the test experiment.

2 Experimental method

Fig. 3 shows a schematic view of the entire set of detectors. A central detector contains the neutrino target materials, water and hydrocarbon, and plastic scintillator bars, and is placed along the beam direction. The muon range detectors (MRDs) consist of one to four detectors in the side region and one detector in the downstream region around the central detector. MC studies in this proposal is performed assuming that one MRD is placed in the side region.

The dimension of the central detector is 100cm \times 100cm in the x and y directions and 200cm along the beam direction. The total water and hydrocarbon masses serving as neutrino targets are ~ 1 ton each. Inside the central detector, plastic scintillator bars are aligned as a 3D grid-like structure, shown in Fig. 4, and spaces in the structure are filled with the neutrino target materials, water and hydrocarbon. When neutrinos interact with hydrogen, oxygen or carbon, in water and hydrocarbon, charged particles are generated. Neutrino interactions are identified by detecting tracks of charged particles through plastic scintillation bars. Thanks to the 3 D grid-like structure of the scintillator bars, the central detector has 4π angular acceptance for charged particles. Furthermore, adopting a 2.5cm grid spacing, short tracks originated from protons and charged pions can be reconstructed with high efficiency. Thin plastic scintillator bars (thickness $\sim 0.3\text{cm}$) will be used for the central detector to reduce the mass ratio of scintillator bars to neutrino target materials, because neutrino interactions in the scintillator bars are a background

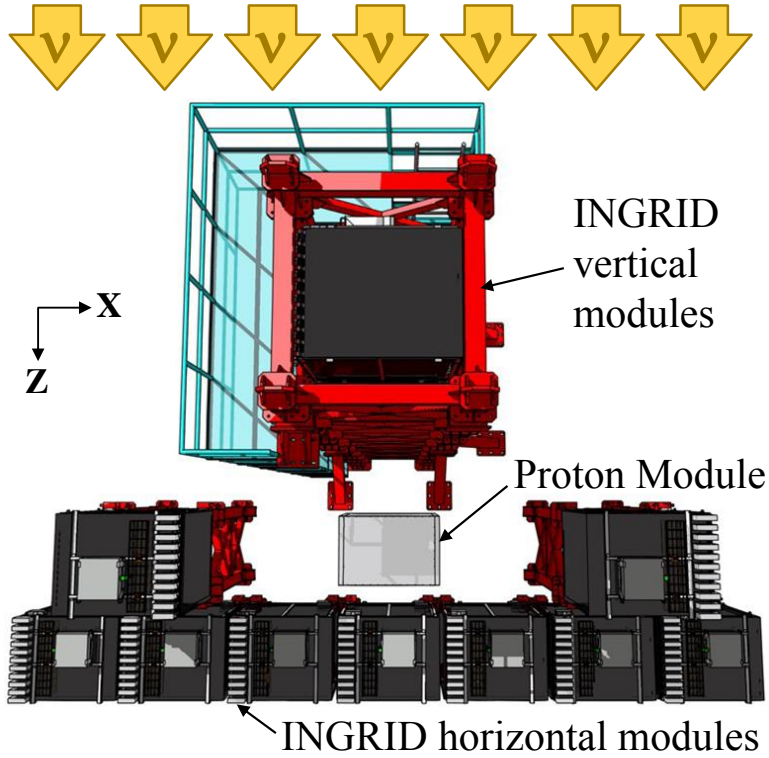

Figure 1: The position of the Proton Module viewed from above.

for the cross section measurements. Scintillator bars whose dimensions are 2.5cm x 0.3cm x 100cm will be used for the central detector. The total number of channels in the central detector is 12880.

The dimension of the MRD in the side (downstream) region is $\sim 200(200)\text{cm} \times \sim 300(350)\text{cm}$ in a plane perpendicular to the muon direction and $\sim 75(230)\text{cm}$ along the muon direction. The MRD in the side (downstream) region consists of 12(30) 3 cm thick iron plates and 14(32) tracking scintillator planes. Muons generated at smaller angle to the beam axis have higher momentum, so the MRD in the downstream region is thicker along the muon direction. Each tracking scintillator layer of the MRD in the side (downstream) region has 25(28) scintillator bars whose dimensions are 20cm x 1cm x 200(200)cm and 20cm x 1cm x 300(350)cm, making a plane measuring $300(350) \times 200(200)\text{cm}^2$ in the horizontal and vertical directions and 2 cm along the muon direction. The total number of channels in the MRD is 1246. The role of the MRDs is the selection of muon tracks from the charged-current (CC) interactions and the rejection of short tracks caused by neutral particles that originate mainly from neutrino interactions in material surrounding the central detector, like the walls of the detector hall, neutrons and gammas, or neutral-current (NC) interactions. The muon momentum can be reconstructed from its range inside the detector. The MRDs are located 50cm away from the central detector to identify the direction of motion of charged particles from the hit-time difference between the two detectors,

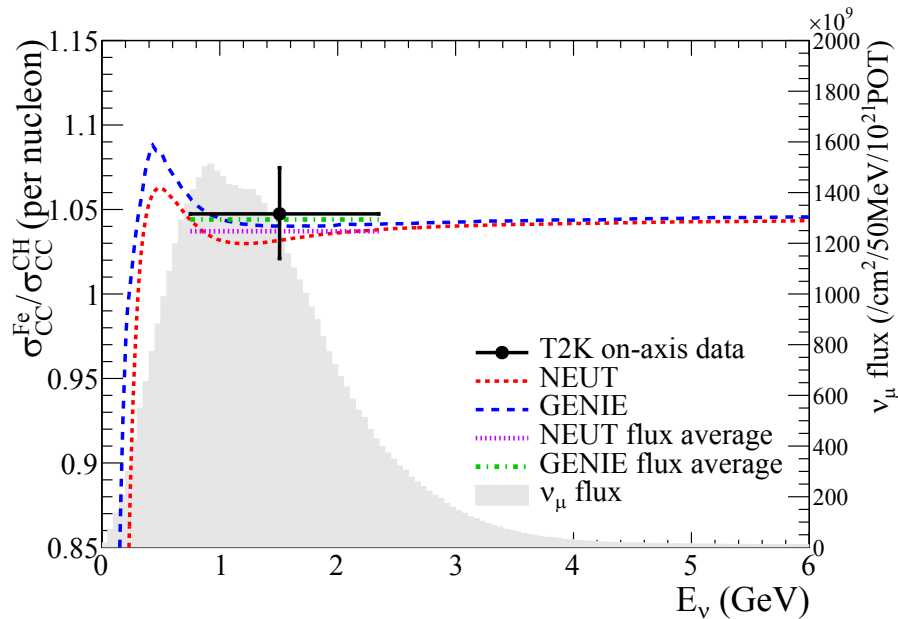

Figure 2: The inclusive ν_μ charged current cross section ratio on iron to hydrocarbon with prediction by neutrino interaction models, NEUT and GENIE.

and reject charged-particle background that originates from neutrino interactions in the material surrounding the central detector, like the walls of the detector hall and the MRDs themselves.

Scintillation light in the scintillator bar is collected and transported to a photodetector with a wavelength shifting fiber (WLS fiber). The light is read out by a photodetector, Multi-Pixel Photon Counter (MPPC), attached to one end of the WLS fiber. The signal from the MPPC is read out by the dedicated electronics developed for the test experiment to enable bunch separation in the beam spill. The readout electronics is triggered using the beam-timing signal from MR to synchronize to the beam. The beam-timing signal is branched from those for T2K, and will not cause any effect on the T2K data taking.

T2K is adopting the off-axis beam method, in which the neutrino beam is directed 2.5 degrees away from SK producing a narrowband ν_μ beam. The off-axis near detector, ND280, is installed towards the SK direction in the B1 floor of the near detector hall of the J-PARC neutrino beam-line. We are planning to install our detector in the B2 floor of the near detector hall, where the off-axis angle is similar, and therefore an energy spectrum similar to ND280 and SK is expected. The candidate detector position in the B2 floor is shown in Fig. 5. The expected neutrino energy spectrum at the candidate position is shown in Fig. 6.

3 Goals of the test experiment

3.1 Basic performance of the detector

We will test the following basic performance of the detector using the neutrino beam data, and confirm the capability of measuring neutrino cross sections on water and hydrocarbon with high precision.

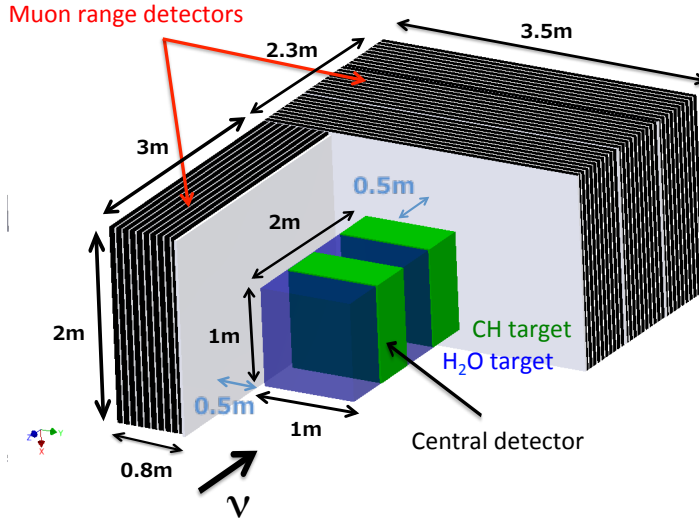

Figure 3: Schematic view of entire sets of detectors.

- Capability of identifying directions of motion of charged particles from the hit-time difference between the central detector and the MRDs
- Track reconstruction efficiency of 99% for an isolated track longer than 10cm
- Particle identification capability, especially for protons and pions or muons, with dE/dx information

Once the performance is confirmed, we will measure the water to hydrocarbon charged current cross section ratio.

3.2 Water to hydrocarbon charged current cross section ratio measurement

We have studied the water to hydrocarbon charged current cross section ratio measurement by using the MC simulation in the Geant4 framework. The simulated event display is shown in Fig. 7.

A neutrino charged current interaction in the central detector is identified by a track from the fiducial volume of the central detector to the MRD located around the central detector, where the MRD is used to identify a long muon track. First, hits are clustered by timing. Then, tracks are reconstructed using hit information. Next, tracks joined between the central detector and the MRD are searched to select long muon tracks which are stopped inside the MRD. After that, charged particles which originate from neutrino interactions in the material surrounding the central detector are rejected with VETO layers, and the determination of the direction of motion of charged particles from hit-time difference between the central detector and the MRD. Finally, the reconstructed event vertex is required to be inside the fiducial volume (FV) of the central detector. The FV of the central detector is defined as a volume within $\pm 45\text{cm}$ from the

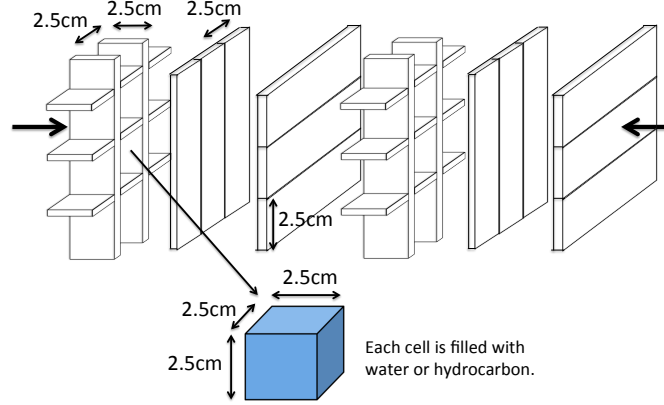

Figure 4: Schematic view of 3D grid-like structure of plastic scintillator bars inside the central detector.

detector center in the x and y directions, and $\pm 95\text{cm}$ from the detector center along the beam direction.

Background events which originate from neutrino interactions in the material surrounding the central detector are evaluated by using MC simulation, and the dominant background source is found to be neutral particles, like neutrons and gammas, from neutrino interactions in the walls of the experimental hall. The distribution of the number of penetrating iron layers in the MRD in the downstream (side) region, for the ν_μ charged current event candidates, is shown in Fig. 8 (Fig. 9). Background originating from neutrino interactions in the material surrounding the central detector can be rejected using the number of penetrating layers in the MRDs. For instance, if events with four (two) or more penetrating iron layers in the MRD in the downstream (side) region are selected, the background contamination fraction can be reduced to a 5% level.

In 1×10^{21} POT of ν beam data, the expected number of the ν_μ charged current event candidates which originate from neutrino interactions in water and hydrocarbon target inside the central detector, after applying the selection on the number of penetrating iron layers in the MRDs, are 21000 each. So, statistical errors will be less than 1% for this measurement. Furthermore, a breakdown of neutrino interaction type of the event sample is shown in Table. 2, and charged current interactions are selected with 92% purity.

The flux-averaged ν_μ CC inclusive cross section is calculated from the number of selected events using the background subtraction and efficiency correction

$$\sigma_{CC} = \frac{N_{sel} - N_{BG}}{\phi T \epsilon}, \quad (1)$$

where N_{sel} is the number of selected events from real data, N_{BG} is the number of selected background events predicted by MC simulation, ϕ is the integrated ν_μ flux, T is the number of target nucleons, and ϵ is the detection efficiency for CC events predicted by MC simulation. The ν_μ CC inclusive cross sections on water and hydrocarbon are measured from the number of selected events in the water and hydrocarbon regions in the central detector. Finally, we will cancel the dominant systematic error, the neutrino flux error, by comparing the cross-section

Near detector hall, B2 floor

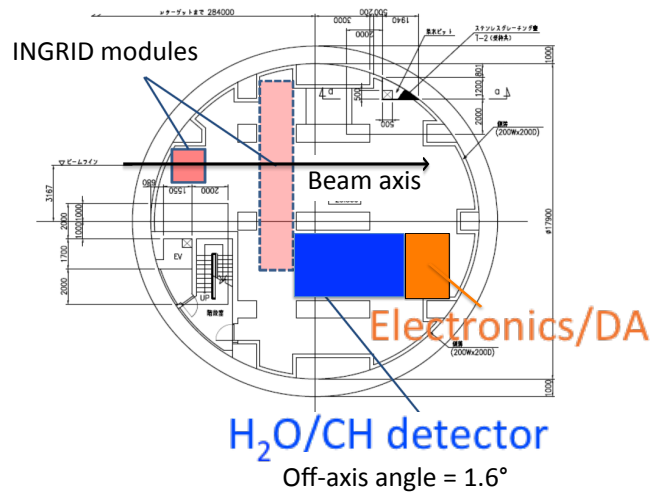

Figure 5: Candidate detector position in the B2 floor of the near detector hall.

results from two neutrino targets, water and hydrocarbon, having almost identical neutrino fluxes, and measure the water to hydrocarbon charged current cross section ratio with 3% precision, which is achieved in the INGRID measurement, as discussed in Sec. 1.

4 Schedule

In 2014,

- May & October: performance test of detector components using positron beam at Tohoku University
- November: completion of testing of the detector components
- December: completion of the detector design

In 2015,

- January - May: procurement and delivery of the detector components
- June - September: detector construction at J-PARC
- October: detector installation into the near detector hall
- November: commissioning
- December : start data taking

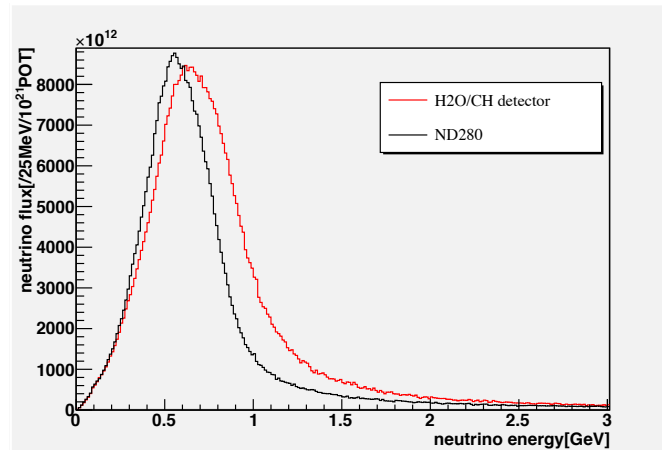

Figure 6: Neutrino energy spectrum at the candidate detector position(red). The spectrum at the ND280 site (black) is also shown.

5 Requests

5.1 Beam condition and beam time

The test experiment can run parasitically with T2K, therefore we request no dedicated beam time nor beam condition.

We request 1×10^{21} POT of ν (not anti- ν) beam data for the test experiment. In order to achieve the goals discussed in Sec. 3, we would like to use the B2 floor of the near detector hall of the J-PARC neutrino beam-line as a test facility of the neutrino beam.

5.2 Request of equipment

We request the followings from April 2015 until a long beam shutdown period after the end of the test experiment.

- Site for the detectors and the readout system ($4\text{m} \times 8\text{m}$) in the B2 floor of the near detector hall (Fig. 5)
- Electricity ($\sim 10\text{kW}$) for the electronics and water circulation system
- Beam timing signal and spill information
- Network connection

The infrastructure for all these is already existing. Equipment such as the detector itself will be covered by external funds.

References

- [1] K. Abe *et al.*, Phys. Rev. Lett. **112**, 061802 (2014).

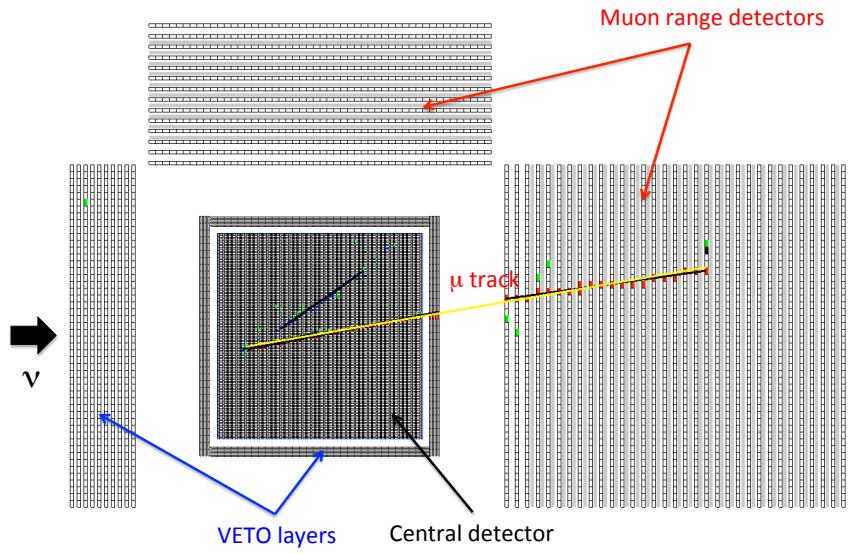

Figure 7: MC event display of a charged current neutrino event in the central detector.

- [2] K. Suzuki *et al.*, "Status of the neutrino cross section measurement in the T2K experiment", The XLIX Rencontres de Moriond QCD and High Energy Interactions (2014).
- [3] Y Hayato *et al.*, Acta Phys. Polon. B **40** 2477 (2009).
- [4] C. Andreopoulos *et al.*, Nucl. Instrum. Meth. A **614** 87 (2010).

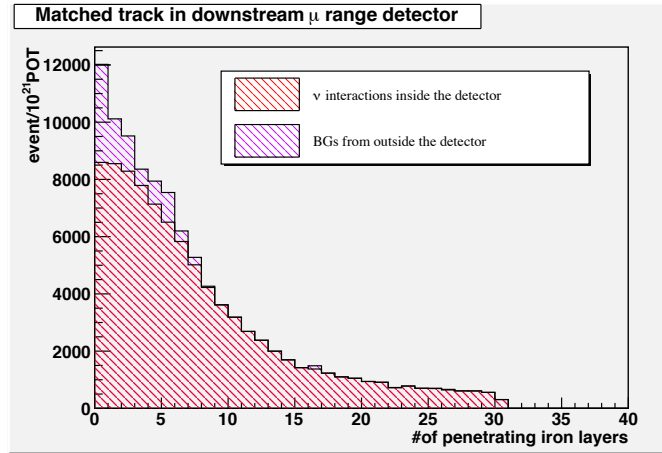

Figure 8: Number of penetrating iron layers in the MRD in the downstream region for the ν_μ charged current event candidates which originate from neutrino interactions in the material inside (red) and surrounding (purple) the central detector.

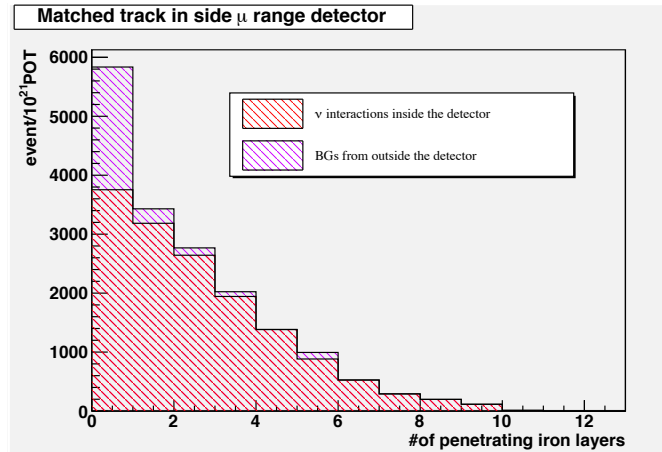

Figure 9: Number of penetrating iron layers in the MRD in the side region for the ν_μ charged current event candidates which originate from neutrino interactions in the material inside (red) and surrounding (purple) the central detector.

Table 2: Breakdown of neutrino interaction type for the ν_μ charged current event candidates which originate from neutrino interactions in water (or hydrocarbon) target inside the central detector, after applying the selection on the number of penetrating iron layers, in 1×10^{21} POT of ν beam data

interaction type	expected number of events in 1×10^{21} POT data	fraction (%)
charged current quasi-elastic scattering	10000	47.6
charged current single pion production	4690	22.3
charged current deep inelastic scattering	4140	19.7
charged current coherent pion production	490	2.3
neutral current single pion production	340	1.6
neutral current deep inelastic scattering	1340	6.4
total	21000	100